

**NABU
PERSONAL
COMPUTER
USER'S
GUIDE**

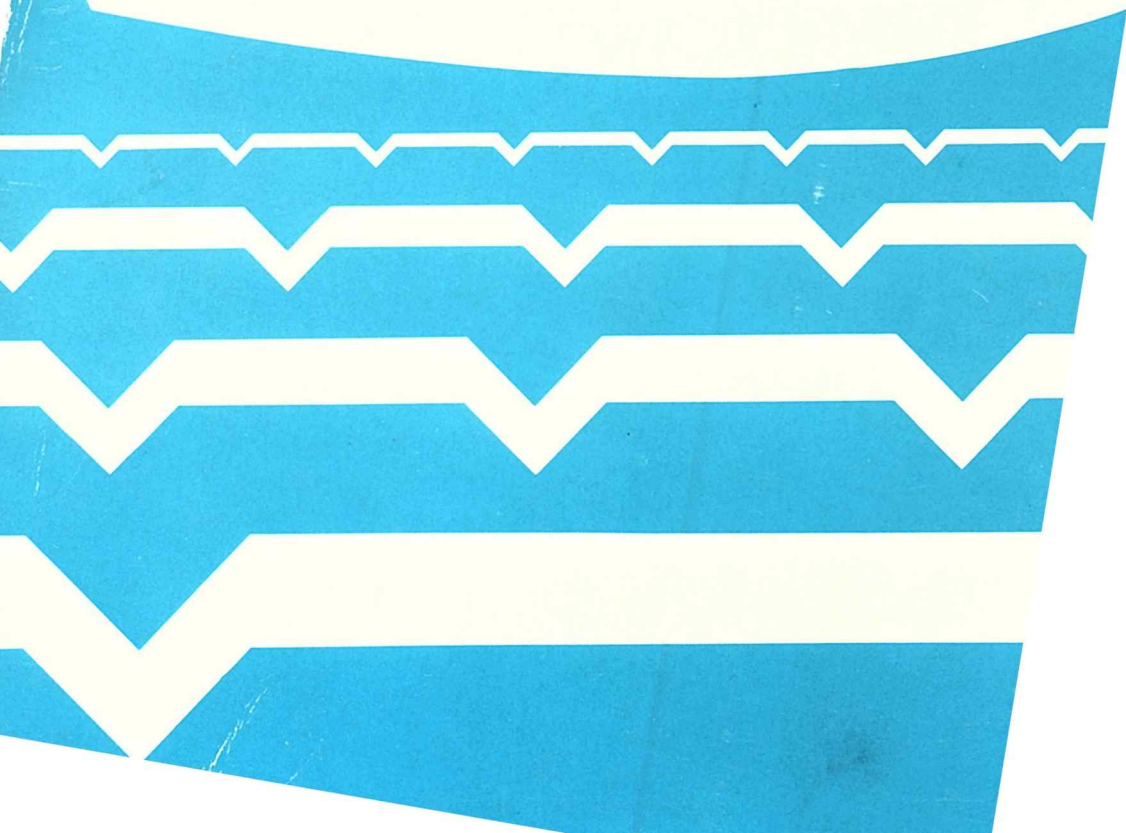

Proprietary Rights Notice:

All rights reserved by NABU Manufacturing Corporation. This material contains the valuable properties and trade secrets of NABU Manufacturing Corporation, embodying substantial creative efforts and confidential information, ideas and expressions. No part of this NABU Personal Computer User's Guide may be reproduced, translated or transmitted in any form or by any means, electronic, mechanical, or otherwise, including photocopying and recording, without the permission in writing from NABU Manufacturing Corporation.

Disclaimer:

NABU Manufacturing Corporation makes no representation or warranty, express or implied with respect to this publication or the programs or information described in this publication, their quality, merchantability, or fitness for any particular purpose, or their adequacy to produce any particular result. In no event shall NABU Manufacturing Corporation, its employees, contractors, or the authors of this publication be liable for specific, direct, indirect or consequential damages.

Order Number: 50212101

Edition History:

First Edition: November, 1982

Second Edition: September, 1983

Copyright © 1983 NABU Manufacturing Corporation.

THE NABU NETWORK[®] is a trade mark of NABU Manufacturing Corporation.

TABLE OF CONTENTS

Introduction	1
Unpacking Your NABU Personal Computer	4
A Quick Tour Of Your Nabu Personal Computer	7
Making The Right Connections	10
Number One	17
Number Two	19
Number Three	21
Getting To Know Your Keyboard	23
Getting Started	30
Using Your NABU Personal Computer	32
If Something Goes Wrong	44
How Does This Cable Work, Anyway?	46
A Computer That Grows With You	49
Quality Features In Your NABU PC	51
NABU PC Technical Specifications	53
NABU Adaptor Technical Specifications	56
Glossary	57

INTRODUCTION

With your purchase of a NABU Personal Computer you have just become part of a unique system, so simple that the whole family can enjoy using it, and so powerful that it encourages all kinds of applications at home and in business. It is unique because it combines your computer with your local cable TV network. In this way, you and your family gain economical access to and use of a virtually limitless storehouse of games, business and educational programs, and informational services.



Relax With Your NABU Personal Computer

About This Guide

We have prepared this book to help you get the most fun and full value from the system. In it, you will find everything you need to know about your computer to get it working with the cable network. You will also learn what you can do to expand your computer's capabilities, and thus your own, even further.

After this introductory section, we'll tell you how to identify things when you've taken them out of the box that they came in, and how to connect them properly. (For those who can't wait, turn to the section on **UNPACKING YOUR NABU PERSONAL COMPUTER** and then to the section on **MAKING THE RIGHT CONNECTIONS**.) Following that, you will learn what to look for and what to do from the time you start up your NABU PC until it tells you it's ready to start work for you. (The NABU PC is the short form used in this manual for the NABU Personal Computer.)

Then comes the part you've been waiting for - how to use your computer! No prior knowledge of computers is needed. A keyboard explanation comes first. Then you learn how to find out what's available on Cable and how to get it into your computer (load it).

Just in case a connector comes loose, or the TV cable system is disrupted, there is a section in this book for diagnosing problems and doing something about them.

After you have grown comfortable with your computer, played games to your heart's content and sampled the many services offered by your cable company, we think you're going to become curious about what makes this combination of computer and Cable work the way that it does, and what else you can do with it. So we've included a brief section on the theory of operation, and another on expansion possibilities.

Finally, for the more technically minded, there is a section which lists the special features and the technical specifications of the NABU PC and Adaptor, and another with a glossary of terms. Though we have tried to avoid unnecessary computer jargon, there are some industry words that are so apt they are rapidly becoming part of our normal language. We think you will want to understand and use them. Some of these terms are explained in the boxed-in descriptions that appear throughout this guide.

Instant Help Sticker

You should have received a HOTLINE number sticker when you subscribed to THE NABU NETWORK. This sticker contains numbers that you will need to set up and use your NABU PC with THE NABU NETWORK. We suggest that you attach the sticker to the side of your NABU PC, so that the numbers

are always available when you need them. The numbers included on the sticker are:

- A **HOTLINE** number where you can call for assistance if you have difficulty with your NABU Personal Computer.
- A **CHANNEL SWITCH SETTING** which tells you which channel to set your TV to before using the NABU Personal Computer.
- A **CHANNEL CODE** which you must enter when you first start up your NABU Personal Computer and after any time you lose power to the Adaptor.

We will explain the use of these numbers again later in this book.

UNPACKING YOUR NABU PERSONAL COMPUTER

The box and packing material that your NABU PC comes in have been designed to give your computer maximum protection during shipping and handling. Everything fits snugly. **DO NOT TURN THE BOX UPSIDE DOWN AND ATTEMPT TO SHAKE THE PARTS LOOSE.**

Remove the inner box before lifting out the keyboard. This inner box contains a games controller and the cables to connect the computer. (You may have received your games controller in a separate package.) As you remove the pieces from both boxes, identify which is which by comparing them with the picture that follows.

The NABU PC Box Contents

This is what you should find in the box labelled NABU PERSONAL COMPUTER:

- NABU PERSONAL COMPUTER USER'S GUIDE (You're reading it now!)
- Your NABU Personal Computer.
- One keyboard.
- One short cable, with a circular single-prong plug at each end.
- One long cable, with a circular six-pin plug at each end.
- One games controller (may have been provided separately).



The Contents of the NABU PC Box

The Adaptor Box Contents

You will also have received a slightly smaller box. It contains some other parts that will be needed for your system. These are:

- One Adaptor with power cord.
- One cable approximately one meter (three feet) long, with a circular single-prong plug on each end.
- One cable approximately one meter (three feet) long, with a circular five-pin plug on each end.

Of course, to complete your system you will use your own TV set and the cable that now connects it to the cable TV outlet.



The Contents of the Adaptor Box

Cable TV and Cables

Incidentally, to avoid confusion in talking about cable TV and inter-connecting cables, from now on we will refer to the "cable" in cable TV, when used by itself, with a capital *C* (Cable); to the interconnecting lines as just cables (with a small *c*); and to the power lines as power cords, (instead of wires or strings or thingamajigs!).

A QUICK TOUR OF YOUR NABU PERSONAL COMPUTER

Take a moment now to examine the major parts of the NABU Personal Computer system.

The NABU Personal Computer

Let's call the large unit, labelled NABU PERSONAL COMPUTER, "computer" for short. It's the central brain where all the calculations, generation of pictures and text, and control of the other parts of the system are carried out. There are some switches and lights on the front panel that you will learn more about in the sections on **GETTING STARTED** and **IF SOMETHING GOES WRONG**.



The Computer

The rear of the computer has:

- Four ports or openings which will take additional circuit cards for expansion of your computer.
- Seven connector sockets. You will be using the sockets labelled **ADAPTOR**, **KEYBOARD**, **AUDIO OUT**, **VIDEO OUT**, **CABLE OUT**, and **CABLE IN** to connect up the basic computer system as described in the next section of this book.
- A **CHANNEL 3-4** switch which is set to the output channel used by your converter, if you have a converter.

The Keyboard

The keyboard has:

- A main set of keys that includes all of the standard typewriter set plus some special function keys which you will learn about in the section on using your NABU PC.
- A keypad containing eight special function keys which are used to move the cursor and the display on the screen, or to reply to questions from the computer.
- A key legend across the top above the main keyset. This describes the special functions of the top row of keys when they are pressed while the **SYM** key is held down.
- Three sockets on the rear panel. Two of these are for connecting up to two games controllers. The third socket is for the long cable that connects the keyboard to the computer.



The Keyboard

The Games Controllers

In addition to the games controller included with your NABU PC, you can purchase an additional games controller to go with your NABU PC. You use games controllers mostly to play the games, but you can also use the games controllers, as well as the keyboard, to tell the computer which programs you want it to load from the Cable. A typical games controller has one or two fire (or firing) buttons, and a joystick that moves in eight directions. Either firing button of the two-button type can be used with the instructions given in this book.

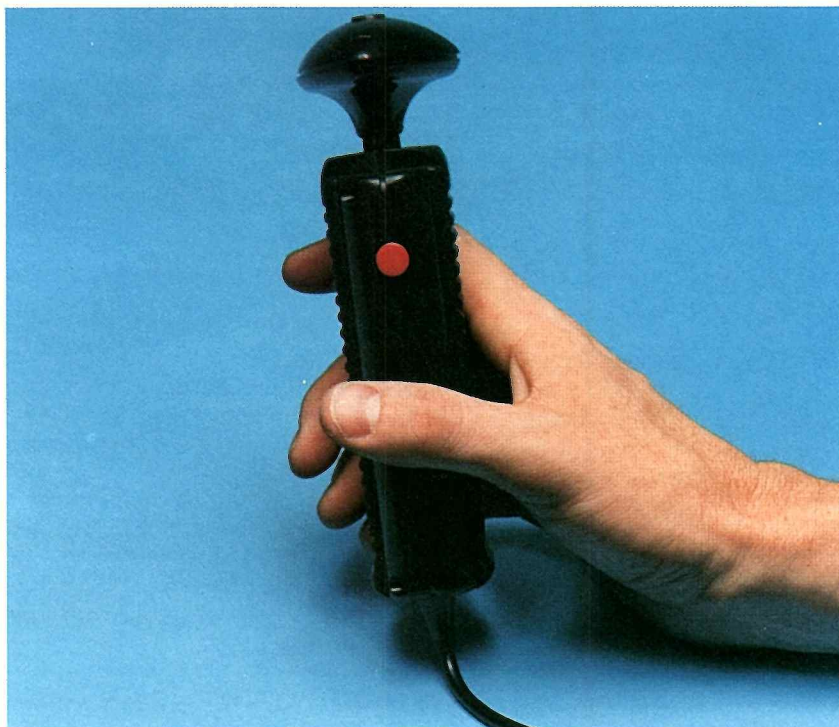

A Typical Games Controller

The Adaptor

The Adaptor is a rectangular box, the same size as your NABU PC, with four lights on the front and connections for a power cord and three cables on the rear. It is a vital part of your system. It selects the right computer programs for you and constantly watches for what is being put on Cable. For this reason, it should always be left plugged in and on. **BUT DON'T PLUG IT IN YET!**

MAKING THE RIGHT CONNECTIONS

Now that you've identified everything that came with your NABU PC, you are ready to connect them all together into a working system. This is what you should have:

- The NABU PC with keyboard, games controller and two cables (everything from the large box).
- The Adaptor with power cord and two cables (everything from the smaller box).
- Your TV set (or video monitor). Your NABU PC will work with any television set designed for North American use, including color and black and white. Of course, the later your model, the better the picture quality. Also, you will enjoy the full benefits of the NABU PC graphics with a color TV.
- A converter (only if you already have one). A converter is a device that lets you receive far more TV stations on Cable than the standard 12 VHF channels that you see on your TV set. The converter may be purchased or rented as a separate unit, or it may have been built into your TV set.
- The cable that now leads from your cable TV outlet to your TV or converter.

Arranging Your System

Before you start to connect anything, you should consider how you want everything to be arranged when you are finished. The illustration shows a typical arrangement. However, you may choose a different one, as long as you observe a few precautions.



A Typical Arrangement

1. Place the parts close enough to suit the length of the interconnecting cables you must use. If it helps your particular arrangement, you can interchange the cables that have identical plugs. For example, the cables that are used between the Adaptor and the converter and between **CABLE OUT** on the NABU PC and the TV set have identical plugs.
2. Avoid putting heavy objects, such as your TV set, on top of the computer or Adaptor. The Adaptor may be placed on top of the computer, but do not place the computer on top of the Adaptor.
3. Leave enough room around the NABU Adaptor and the NABU PC to let air flow freely under, in front of, beside and behind both units.

One other precaution!

If any of the components such as the screen become smudged or dusty, they may be wiped gently with a damp (NOT WET) cloth. Never use solvents or waxes. Never use a wet cloth, as water dripping inside a unit could severely damage it.

Your NABU Personal Computer is rugged, but like any sophisticated electronic device, it can break down if handled carelessly. Please don't drop it, step on it, get it wet or otherwise abuse it. It depends on you for protection!

Which Connections to Use

There are three different ways to connect the parts of your computer system. Which you must use depends on your present TV set.

If you have a standard TV without a converter, refer to the illustration and directions under the heading **NUMBER ONE** to connect the right cables to the right sockets.

If you have a "cable-ready" TV (with the converter built into the TV set), refer to the same illustration and directions under the heading **NUMBER ONE**.

If you have a standard TV which uses a separate converter with or without a separate Pay-TV descrambler, refer to the illustration and directions under the heading **NUMBER TWO**. (The converter and Pay-TV units may be physically separate or they may be combined in one unit.)

If you have component or modular TV (with a separate "TV tuner"), refer to the illustration and directions under the heading **NUMBER THREE**.

Be careful that you match the correct plug with the correct socket. Checking the shape and matching the number of pins and holes should help decide which goes with which.

There are four types of sockets and plugs: type-F, 5-pin DIN, 6-pin DIN, and type-D. (Refer to **Connector Types**.) You shouldn't have to use more than a firm push to get the right plug and socket together. After the type-F connectors are joined, turn the threaded nut clockwise until they are pulled snugly together.

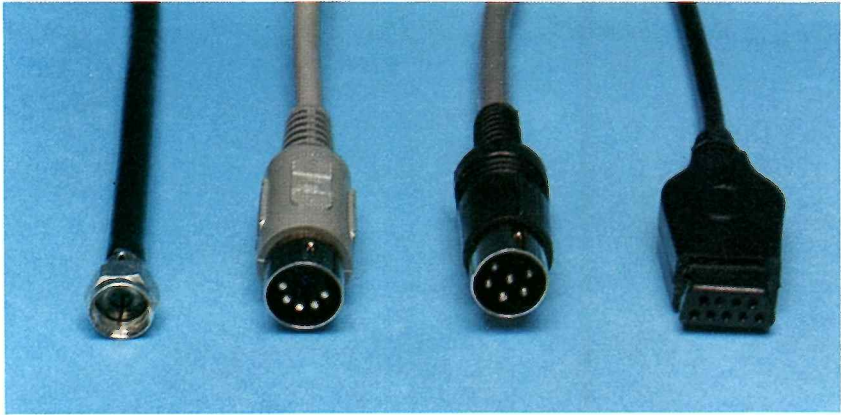

Type-F

5-pin DIN

6-pin DIN

Type-D

Connector Types

Refer to the large illustrations of the rear panels of the NABU PC, the Adaptor and the keyboard for the location of the sockets labelled in the interconnection instructions. Also shown are typical connections found on the backs of most TV sets. The circled number on each cable in the connection diagrams refers to the number of the step in the instructions.

You may also connect a video monitor to the configurations in **NUMBER ONE** and **NUMBER TWO**. If you have both a monitor and a TV set connected to your NABU PC, you will be able to watch TV and work with the computer.



ADAPTOR

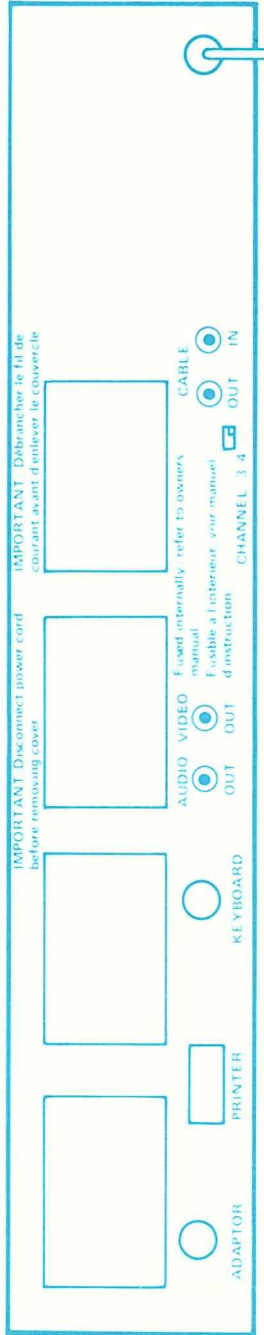

Connections on Rear Panels

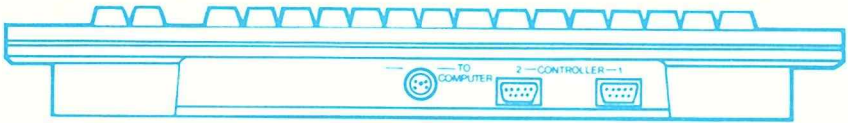

Keyboard Rear Panel

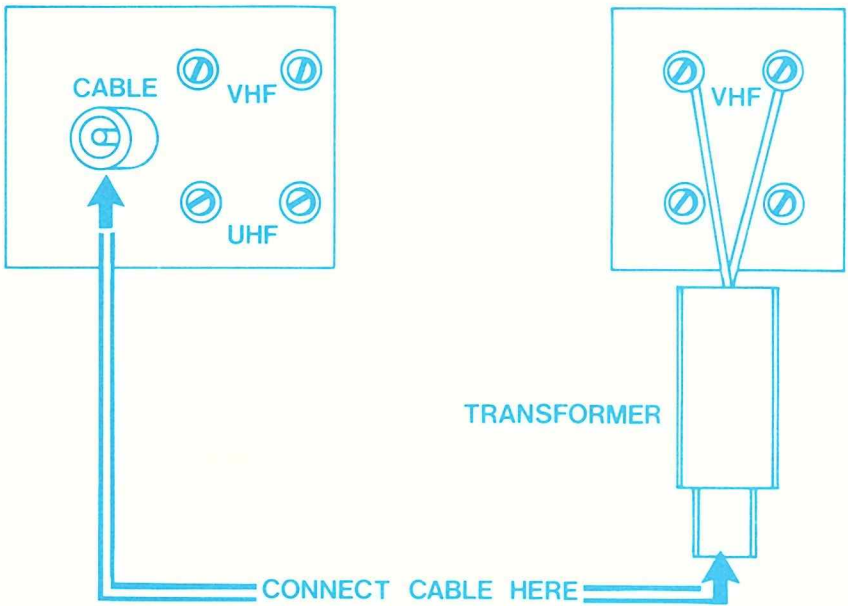

Typical TV Connections

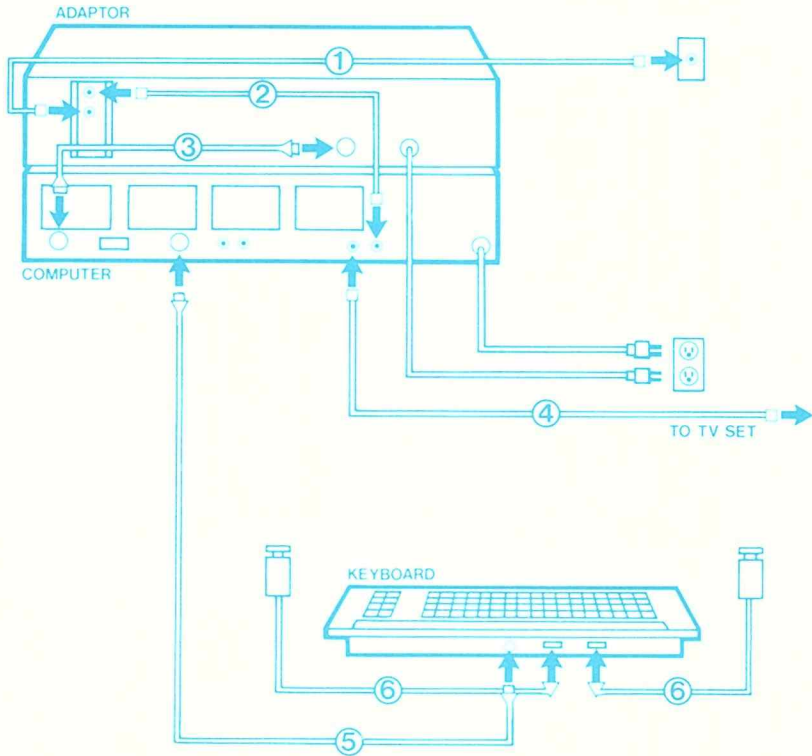

Connections for Standard TV With No Converter or for
"Cable-Ready" TV With Built-In Converter (Number One)

NUMBER ONE

For Standard TV, With No Converter, and

For "Cable-Ready" TV With Built-In Converter

1. Disconnect the cable from your TV and connect it to **CABLE IN** on the Adaptor.
2. Connect one of the type-F connector cables to **CABLE OUT** on the Adaptor and to **CABLE IN** on the NABU PC.
3. Connect the short cable with the 5-pin DIN connectors to **COMPUTER** on the Adaptor and to **ADAPTOR** on the NABU PC.
4. Connect the remaining type-F connector cable to **CABLE OUT** on the NABU PC and to your TV set. Some TV sets are connected to Cable via a small cylindrical transformer attached to the TV antenna terminals. If so, connect the cable to the free end of this transformer. However, if your set has a separate built-in (75 ohm) connector for Cable, use it instead.
5. Connect the long, 6-pin DIN connector cable to **KEYBOARD** on the NABU PC and to **COMPUTER** on the keyboard.
6. If you have just one games controller, it must be connected to receptacle **1** on the keyboard. If you have a second games controller, connect it to receptacle **2**.
7. If you have a separate video monitor, connect **AUDIO OUT** and **VIDEO OUT** on the NABU PC to a set of audio and video inputs on the monitor. You must provide your own cables for this step. The computer ends of the cables for these connections must have phono jacks.

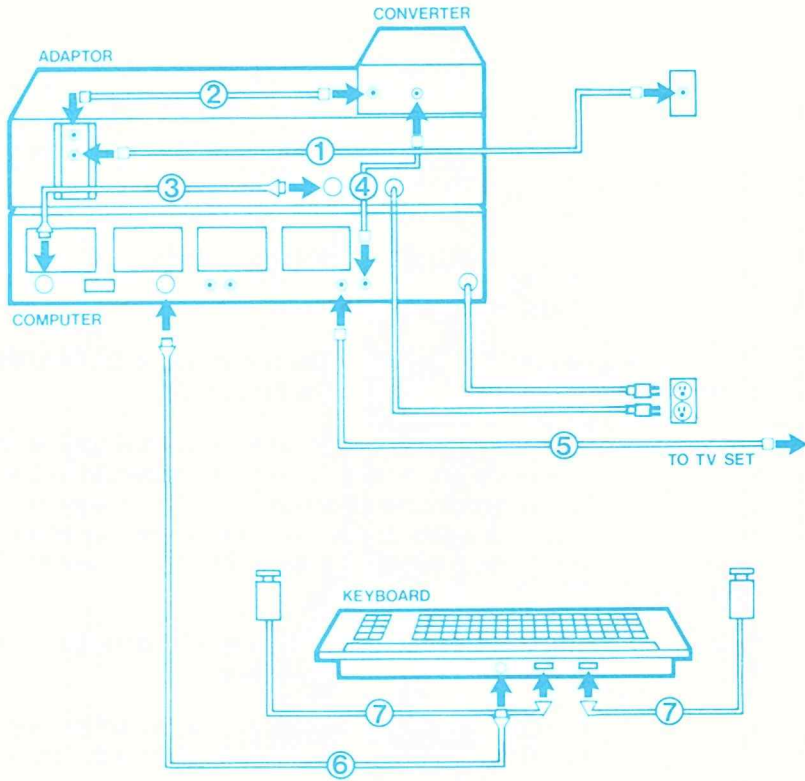

Connections for TV Sets With Separate Converters
With or Without Pay-TV (Number Two)

NUMBER TWO

For TV Sets With Separate Converter

With or Without Pay-TV

1. Disconnect the cable from the Cable input connection on the converter (or combined Pay-TV converter, if you have one), and connect it to **CABLE IN** on the Adaptor.
2. Connect one of the type-F connector cables to **CABLE OUT** on the Adaptor and to **CABLE IN** (or a similar label) on the converter (or if you have one, to the combined converter/Pay-TV unit).
3. Connect the short cable with the 5-pin DIN connector to **COMPUTER** on the Adaptor and to **ADAPTOR** on the NABU PC.
4. Disconnect the cable that now leads from your converter or separate Pay-TV unit or the combined unit, where it connects to the TV, and connect it to **CABLE IN** on the NABU PC. Some TV sets are connected to Cable via a small cylindrical transformer attached to the TV antenna terminals. If so, connect the cable to the free end of this transformer. However, if your set has a separate built-in (75 ohm) connector for Cable, use it instead.
5. Connect the remaining type-F connector cable to **CABLE OUT** on the NABU PC and to the receptacle on your TV from which you removed the cable in step 4 above.
6. Connect the long 6-pin DIN connector cable to **KEYBOARD** on the NABU PC and to **COMPUTER** on the keyboard.
7. If you have just one games controller, it must be connected to receptacle **1** on the keyboard. If you have a second games controller, connect it to receptacle **2**.
8. If you have a separate video monitor, connect **AUDIO OUT** and **VIDEO OUT** on the NABU PC to a set of audio and video inputs on the monitor. You must provide your own cables for this step. The computer ends of the cables for these connections must have phono jacks.

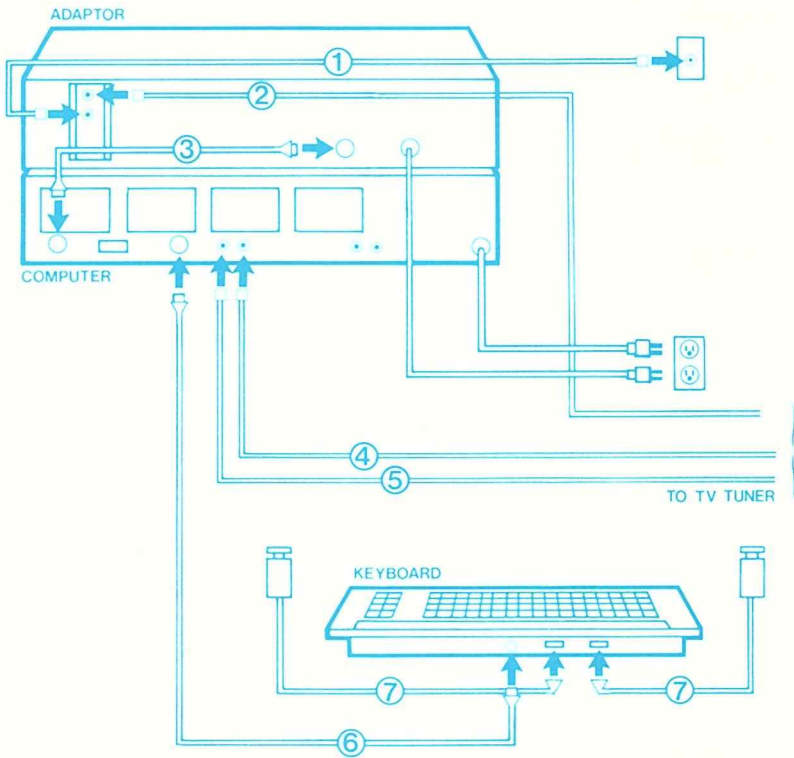

Connections for Component or Modular TV (Number Three)

NUMBER THREE

For Component or Modular TV

1. Disconnect the Cable input connection on the back of your TV tuner, and connect it to **CABLE IN** on the Adaptor.
2. Connect one of the type-F connector cables to **CABLE OUT** on the Adaptor and to the Cable input on your TV Tuner Module. (You will not need the remaining type-F connector cable unless you wish to use the **TV<-->NABU** key feature. If so, connect the Adaptor **CABLE OUT** to the PC **CABLE IN**. Use the remaining cable to connect the PC **CABLE OUT** to the TV or Cable input on your TV tuner. You must then select THE NABU NETWORK channel on the TV setting of the tuner.)
3. Connect the 5-pin DIN connector cable to **CONTROL** on the Adaptor and to **ADAPTOR** on the NABU PC.
4. Connect **VIDEO OUT** on the NABU PC to one of the video inputs on your TV tuner. One end of this cable must have a phono jack. Refer to your TV owner's manual for the type of cable and the connector required for your TV.
5. Connect **AUDIO OUT** on the NABU PC to the audio input on your TV tuner associated with the video input in step 4 above. One end of this cable must have a phono jack. See your TV owner's manual for cable details.

Note: The video and audio cables for steps 4 and 5 above are to be supplied by the user.

6. Connect the long 6-pin DIN connector cable between **KEYBOARD** on the NABU PC and **COMPUTER** on the keyboard.
7. If you have one games controller, connect it to receptacle **1** on the keyboard. If you have a second games controller, connect it to receptacle **2**.

The Power Cords

NOTE

If the equipment has been exposed to extreme cold temperature, such as outside winter temperatures, allow at least one half hour at normal room temperature before turning it on.

Plug the power cords for your Adaptor and your NABU PC into 115-Volt AC outlets. These are common household outlets, but notice that for the Adaptor and the computer, at least, they must be the type into which a three-prong plug will fit. (Plug in your converter, Pay-TV unit and TV as they were before you started to add your NABU PC.)

When you plug the Adaptor power cord in, check that the green POWER light on the Adaptor comes on. There is no power on and off switch on the Adaptor for the very good reason that we would like you to leave it on all the time. (It uses about as much power as a 25 watt light.)

The NABU PC, however, does have a POWER switch, but don't turn it on just yet! We are not quite ready!

Setting the CHANNEL 3-4 Switch

If you are using a converter with your system, you will have to tell your computer what channel the converter changes everything to.

- Find the CHANNEL 3-4 switch on the rear panel of your PC.
- Set the switch to the channel number specified on the sticker that you received with your computer.

Even if you do not have a converter, you should set this switch to the channel specified on the sticker. It is the channel which is least likely to be interfered with by any nearby broadcasting TV stations. It is also the channel that you will set your TV to when you are using the NABU PC.

GETTING TO KNOW YOUR KEYBOARD

The keyboard and the games controllers are the keys that let you “in” to your NABU PC. They are your means of talking to the computer and telling it what you want it to do.

Of the two devices, you will probably communicate with the computer more often through the keyboard because it offers the most flexibility.

The keyboard looks something like a typewriter and can be used like a typewriter, except that instead of printing directly on paper, it “prints” on the TV screen.

There are some other differences that you need to know. For instance for the number “one”, you must use the **1** key in the top row of your keyboard. (Some typewriters use the lower case letter “ell” (l) for the number 1.)

Your keyboard also has some special keys with labels, such as **SYM** and **TV<-->NABU**, that do not appear on typewriter keyboards.

The meaning of many of these keys is obvious and gives you a clue as to what the computer can do (for example, the **HELP** key suggests that the computer will tell you what to do if you use that key).

Still another difference from the typewriter is that the same key on your keyboard can have different uses (functions) depending on which program you are using (refer to **What's a Program?**). The written instructions that go with the program (and sometimes the instructions displayed on your screen) will tell you which keys have special functions. These may differ from what this book or your keyboard labels tell you.

What's a Program?

A "program" is nothing more than a long list of instructions that tell your computer what to do. The instructions in a game program, for example, tell your computer when and how to create the special effects that you see on the screen, when to send you a message, how to keep track of the score, or what to show on the screen if you hit a key or use the games controller.

When you choose a particular item during the final stage of selection, you are really selecting a ready-made program to transfer into your computer. Each game you select, for example, is a program.

There are other kinds of programs, of course. For example, you may select a stock market program that you will use to check the current stock market trends. Or you may use a metric conversion program that lets you convert weights and measures to metric.

All of these ready-made programs are sometimes called "applications" because each is designed for a special use (or application), whether it's for the game of backgammon, for keeping up-to-date with the stock market, or for metric conversion.

The Special Function Keys

Right now, we can tell you about certain special function keys on your keyboard that will not be changed by any program you select. They are used by you at any time to:

- Suspend the computer operation.
- Switch you over to normal TV and back to the computer.
- Answer the computer's questions.
- Put you back at the beginning of your program.
- Move your cursor.
- Change page displays.

And, oh yes, there is also an autorepeat function.





What's Autorepeat?







“Autorepeat” means that the action that results when a key is pressed will be repeated as long as the key is held down. For example, if you hold the **A** key down, the computer will display a row of A's (slowly at first, then faster) until you let the key come up. Autorepeat works on all the keys on the main keyboard except those labelled **ESC, CTRL, CAPS, SYM, SHIFT, PAUSE** and **TV<-->NABU**.









Since you will be using the keyboard from the moment you first start up your NABU PC, we will describe these special function keys at this point in this book. Some of the references we use in the descriptions (for example, category, menu and cursor) will be clearer after you read the section on **USING YOUR NABU PC**. You can always return to the table that follows to refresh your memory about the function of the keys.





The NABU PC Keyboard

The Key	What It Does
	<p>This key has the same function as on a typewriter. While it is pressed, the SHIFT key causes letter keys, which are pressed, to print uppercase (capitals). When it is used with keys that have two characters on them, (for example, the 1 and ! key or the 2 and @ key), it prints the upper character (! and @ in our example).</p>
	<p>Press the CAPS key down and it locks down. While it is down, it causes any letter key that is pressed to print in uppercase. This lets you type uppercase letters in combination with numbers without having to use the SHIFT key. To release the CAPS key, press it again.</p>
	<p>The SYM key, like the SHIFT key, is also held down while you press another key. The SYM key causes the other key to do something completely different than what is shown on the key itself. On your computer, SYM is used with the ESC, ±, PAUSE and TV<-->NABU keys to change their uses to BREAK, RESTART, EXIT, and HELP respectively. The legend above the top row of keys on your computer tells you what alternate use you get from specific top row keys when you use the SYM key. The four keys mentioned above always have the special use we have shown. However, the number and dash keys in the top row can be assigned different functions by different programs.</p>
	<p>The GO key tells the computer when to act on some other instruction. For example, during selection, you first instruct the computer to "point" to a category by moving the cursor. Then you hit the GO key (or firing button) to cause the computer to actually select that category and display its pages.</p>

The Key	What It Does
 (cont.)	<p>Often the GO key is used after another key to tell the computer that you want it to act on what the first key says.</p>
	<p>The DELETE key moves the cursor back one space and deletes any character that may have been in that space.</p>
	<p>The TV<-->NABU key is used to switch you over to watch normal TV while your computer continues to work unseen in the background. If you have given the computer a long job to do, for example, you can watch your favorite TV channel just by pressing TV<-->NABU, and then selecting a TV channel as you normally would. To get back to the computer, just press TV<-->NABU again and make sure your TV is set to THE NABU NETWORK channel. Normally, this key is not used with component TV.</p>
 (SYM & )	<p>The HELP key acts exactly as if you selected the word HELP shown on the selection displays. When you press TV<-->NABU while holding the SYM key down, instructions will show up on the screen which relate to whatever you were doing just before you asked for HELP. When you are finished with them, the instructions will tell you how to return to what you were doing.</p>
	<p>Pressing the PAUSE key freezes the computer action and causes the yellow PAUSE light to come on. (You may want to pause while you answer the phone or get ready to play a game.) To start up again from where you stopped, press PAUSE again.</p>
 (SYM & PAUSE)	<p>Using EXIT from a program puts you right back to the display of a selection page. Using EXIT from the first selection display will display the farewell messages.</p>

The Key	What It Does
 (SYM & \pm)	Using RESTART puts you back to the start of your present program. If you are playing a game and for some reason want to start it at the beginning again, press SYM and the \pm key.
 (SYM & ESC)	The BREAK function is used with an optional dial-up capability you can get for your NABU PC (refer to the section called A COMPUTER THAT GROWS WITH YOU). Dial-up will let your computer talk to another computer by telephone. When you have dialed the other computer's number on your keyboard, you press SYM and hit ESC to let the other computer know that you want it to stop whatever it is doing and let you break in.
	The YES key is used to answer "yes" to a question asked by the computer.
	The NO key is used to answer "no" to a question asked by the computer.
	The up arrow moves the cursor up one line of text or it moves it up to the selection line above the cursor's present position (refer to What's a Cursor? for an explanation of "cursor").
	The down arrow moves the cursor down one line of text, or it moves the cursor to the selection line immediately below the cursor's present position.
	The left arrow moves the cursor to the left by one character space when you are working with text.
	The right arrow moves the cursor to the right by one character space when you are working with text.

The Key	What It Does
 	<p>The backward page key moves you backwards through the pages in the second selection stage. It is also used for a similar task in other programs.</p> <p>The forward page key moves you forward through the pages in the second selection stage. It is also used for a similar task in other programs.</p>

What's a Cursor?

“Cursor” is a technical word that existed before computers. It originally referred to the fine line in the plastic slide on a slide rule. Now it refers to any device or symbol that you (or the computer) can move around on the screen to indicate where an action should take place. When you are typing characters, normally the cursor is a flashing dash or rectangle which indicates where the next character to be typed will appear on the screen.

GETTING STARTED

Now that you have been introduced to your keyboard and you have all of the parts of your NABU PC securely connected, it's time to start up your computer system.

1. Turn the TV on as you normally would.
2. Select a normal TV channel and ensure the color and sound are to your satisfaction.
3. If your TV does not have a separate converter, select THE NABU NETWORK channel (channel 3 or 4 as specified on the sticker that you were given).
4. Push the **POWER** switch on the front of the NABU PC to the ON position. If everything operates smoothly, this is what you should see and hear over the next 5 to 20 seconds.

On your PC:

- All four lights will light up for about three seconds.
- The green **ON** indicator on the left front will stay on.
- The remaining lights will turn off.
- The red **ALERT** light will stay off.
- The yellow **PAUSE** and the green **CHECK** lights will turn on and off separately or together.

On the TV screen:

- The NABU logo will appear.
- A series of high-pitched "beep" sounds will occur.

There's more to come, but let's pause long enough to explain that your NABU PC has just put itself and the rest of the system through a self-test. It has checked each section of its memory, its sound generators, the keyboard and the connection to the Adaptor.

If any test fails, you will hear a low-pitched sound; one or more messages will appear on the screen; the red **ALERT** light on the NABU PC will come on; and the yellow **PAUSE** and green **CHECK** lights will remain on or off as they were when the low-pitched sound occurred.

One of the messages you may see refers you to the section of this book called **IF SOMETHING GOES WRONG**. It's a good idea to refer to that section any time you have a problem.

Normally, everything will check out okay, all lights except the **POWER ON** light will go off, and you will see a message come on the screen asking you to **PLEASE WAIT**.

5. *IF THIS IS THE FIRST TIME YOU HAVE USED THE COMPUTER SINCE PLUGGING IN THE ADAPTOR POWER CORD*, you will see a message on your screen to **PLEASE TYPE IN CHANNEL CODE**. Your channel code is specified on the sticker. Your NABU PC needs this code to tell the Adaptor what Cable channel the local cable company has assigned to **THE NABU NETWORK**.

(If you accidentally pull the plug on your Adaptor or you have a power failure, the next time you start up you will get this same request to type in your channel code. That's why we recommend that you attach the sticker to the side of your NABU PC, so the numbers are always available when you need them!)

If you haven't already done so, type in the channel code and press the **GO** key. (You will see the green **CHECK** light on the NABU PC flashing each time a key is pressed. This is normal.)

If you don't type it in correctly, there's a good chance the computer will know something is wrong with it. If so, it will ask you to type in the channel code again.

6. Now you will see the message to **PLEASE WAIT**. Your NABU PC is transferring information to itself from the Cable. Except for the green **POWER** light on your computer, all the lights on the panel will be out. After your NABU PC has located the program it is looking for on Cable, you will hear a sound with a rising pitch (getting higher) to let you know that the transfer to your computer's memory is going well.

If the transfer does not go well, the sound will stop rising in pitch. Push the **RESET** switch on your computer. This will cause the system to try again. If you encounter the same problem again, please turn to the section entitled **IF SOMETHING GOES WRONG**.

Of course, we expect that everything will proceed normally and the final occurrence in this startup procedure will be the appearance of an animated display. This display is the signal that your computer is ready for you to make your selections from the Cable system.

USING YOUR NABU PERSONAL COMPUTER

Using your NABU PC requires just these three steps:

- Step 1: Select the specific item (game, information service, business program, etc.) you want.
- Step 2: Use the keyboard or games controllers to interact with the item, for example, to play the game if you have selected a game.
- Step 3: When you have finished with that item, select another or turn your computer off.

As we describe each of these steps, we will tell you exactly what to do. **Each time we give you an action to take, we will use boldface type similar to what we have used in this sentence.**

And, remember, don't be afraid! No matter what keys you hit or what controls you operate, you will not hurt the computer.

Step 1: Selecting an Item

The animated display that comes on your TV screen, right after your computer has completed its self-test, eventually will change to a selection display. However, if you want to cut short the animation and get on with selecting something from Cable, **press the GO key or the firing button on the games controller.**

Note: If you are using a games controller for selection, use only the games controller plugged into receptacle 1 on the keyboard.

You can go through several stages to select an item from Cable, or you can select it directly at the first stage. The stages are a short series of steps that lead you through indexes (called "menus" in the computer world) of everything being offered on Cable.

The first menu lists the names of the categories that correspond to the packages offered by your cable company. The next menus list the individual items or programs offered in each of the categories.

For a full explanation, you should read the following pages. But for the impatient or the adventurous, here are some brief instructions:

- Stage One**
- Press the arrow keys or move the joystick to move the cursor to a category name such as FAMILY, GAMES or EDUCATION; when the name you want is highlighted, press the GO key. Alternatively, type the number of the category you want and press the GO key.
- Stage Two**
- Press the page keys until you find the item you want and are entitled to use; use the arrow keys or the joystick as in stage one, to move the cursor to the item; press the GO key.
- Direct Selection**
- Move the cursor to SHORTCUT; when SHORTCUT is highlighted, press GO; type the name of the item; press GO again.

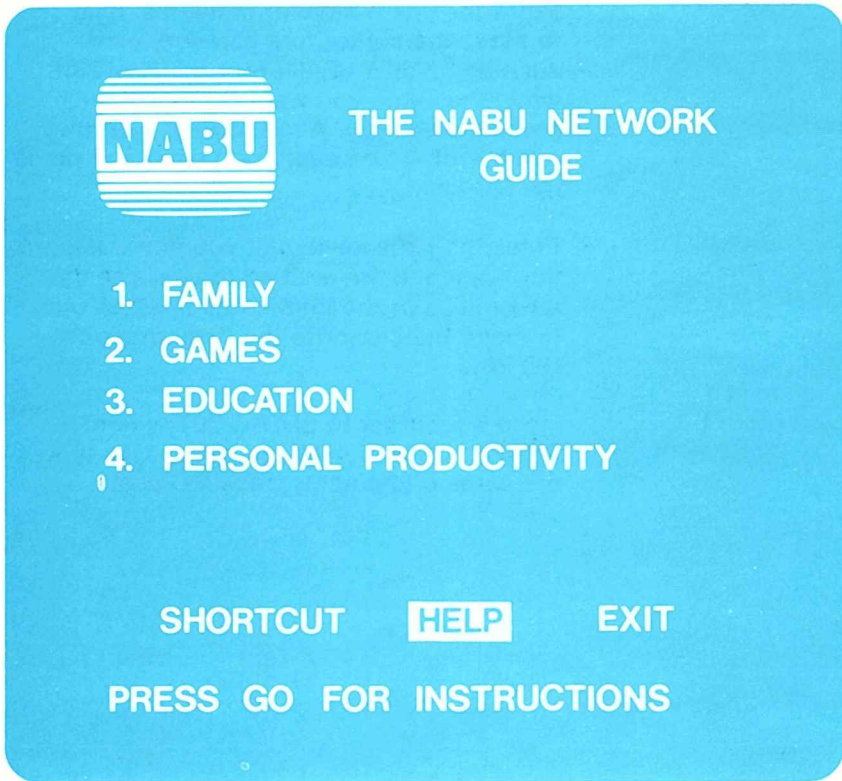

Stage One Selection

Stage One

The first stage of selection uses the display with the title THE NABU NETWORK GUIDE from which to select one of the main categories of items offered on Cable. Typical category names are FAMILY, GAMES and EDUCATION. (The category names that appear on your display may be different from these.)

Your display of the main menu will be similar to the illustration on this page. The numbered lines show the names of the categories available through your cable company. In stage one of the selection, you choose a category by number or by name.

To select a category by number:

- **Type the number that you see on the screen next to the category name you want and press the GO key.**

To select a category by name:

- **Use the arrow keys or the joystick to move the cursor to the name of the category you want. When the line containing the name becomes highlighted, (light text becomes dark on a light background), press the GO key or the firing button.**

To move the cursor with the arrow keys:

- **Note where the cursor is presently located.**
- **Press the up or down arrow key that points in the direction you want to move the cursor.**

Each time you press this up or down arrow key, the cursor will jump to the preceding line or to the next line. If it is a category line, the line will become white and any text on the line will become blue.

To move the cursor with the joystick:

- **Note where the cursor is presently located.**
- **Move the joystick forward or backward to cause the cursor to move up or down a line.**

Each time you move the joystick, the cursor will jump to the next line and that line will change just as described for the movement using the arrow keys.

If you continue to move the cursor up or down, it will "wrap around" to the second line from the bottom or to the top line.

The moment you press the **GO** key or the firing button, the displays for the next stage of selection will appear. (You will also hear a tone if the volume on the TV is set high enough.) But before we go on to this next stage, let's find out what these other sections displayed on the main menu will do for us. They represent special features called, **SHORTCUT**, **HELP**, **EXIT** on one line and a banner line on the bottom line.

The SHORTCUT Feature

If you already know the name of the final item that you want, you can use **SHORTCUT** to skip the intermediate stages.

To do this:

- Use the arrow keys or the joystick to move the cursor over the word **SHORTCUT** so that the word is highlighted.
- Press the **GO** key or firing button. The line below **SHORTCUT** will become white.
- Type in the exact name of the item you want. If you make a mistake in spelling the name, press the **DELETE** key to erase as many characters as you want.
- Press the **GO** key or the firing button and wait for your program to be loaded from Cable.

The HELP Feature

When you first see the selection display, the word **HELP** is already highlighted. Pressing the firing button or the **GO** key at this time will bring instructions that tell you how to select from this first-stage display.

You can get help at any time while using your computer by pressing the **HELP** key. While the category menu is displayed, you can also get help at any time if you:

- Press the firing button or the **GO** key while **HELP** is highlighted, and follow the directions that show up on the screen.

If **HELP** is not highlighted:

- Use the up or down arrow keys or the joystick to move the cursor to the special features line containing **HELP**.
- Use the left or right arrow keys, or move the joystick left or right, to move the cursor to **HELP**.
- Press the **GO** key or the firing button.

The EXIT Feature

Whether you are making a selection or playing a game or interacting with any program, there are times when you want to get out of it or quit. In computer language, this is called "exiting". Normally when you exit, you go back to where you were before you got into your present stage or program.

You can use the **EXIT** key (**SYM & PAUSE**) on the keyboard to exit at any time, including while you are displaying a menu. However, you may also exit from a menu by using the EXIT feature displayed on the screen:

Use the arrow keys or the joystick to move the cursor to the word, EXIT.

When EXIT is highlighted, press the GO key or the firing button.

(Using the EXIT feature from the main menu will put the farewell messages on the screen. More about that later.)

The Banner Line

To help you make your selections, THE NABU NETWORK displays special information on the menu screens. This information is printed out on what is called a "banner line" located at the bottom of your screen. For example, when you first displayed the menu, the HELP feature was highlighted, and the line at the bottom suggested that you PRESS GO FOR INSTRUCTIONS.

Stage Two

When you select a category from the first stage of selection, your computer will then display the items that are in that category. It is now ready for the second stage of selection.



Typical Second-Stage Selection Display

There are so many items offered in some of these categories that they can't all be shown in one display. So they are arranged in "pages", where each page is a different screen display naming several items in a particular category.

You use the paging arrows in the bottom row of the keypad or the games controller to move forward or backward through the pages. If you imagine all the pages pulled out of a four-page booklet and spread out like the following illustration, you will get the picture.

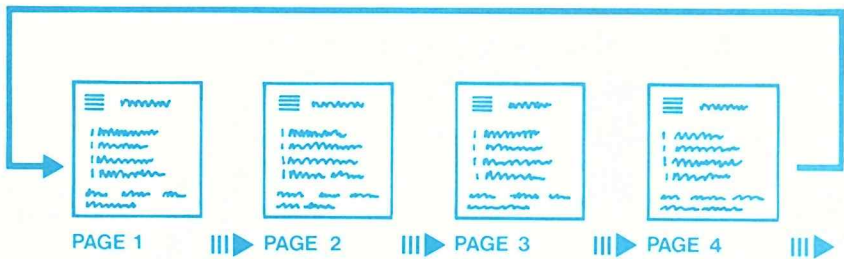

Paging

To page forward (to the right):

- **Press the right-pointing (forward) paging key on the bottom row of the keypad.**

or

- **Move the joystick to the extreme right until a flashing paging symbol appears on that side.**
- **Press the firing button.**

To page backward (to the left):

- **Press the left-pointing (backward) paging key.**

or

- **Move the joystick to the extreme left and press the firing button.**

You can keep moving forward to the right until you run out of new pages for that category. You will know you've run out because the first page will be displayed again! (If you move backward, to the left, from the first page, you will get the last page of items for that category.)

Each page is organized the same way. The title at the top of each page is to remind you which category you are in. The list of items, identified by number and name, may be used to make a selection.

The bottom of the page should be familiar! There are the same three special features and a banner line that you found in the first-stage display. They are used the same way too, except that selecting EXIT will put you back in the first stage ready to select a category again.

You can select an item by number, by highlighting the line with the name on it, or by using the SHORTCUT. The cursor is moved with the arrow keys or the number one games controller as described in the instructions for the first selection stage.

If you remember the number of the item you want:

- **Type the number.** You must be in the category the item belongs in, but the page that lists the item does not have to be showing.
- **Press the GO key.**

To select an item by highlighting:

- **Use the paging keys or the joystick to move through new page displays until you have found the page listing the name of the item you want.**
- **Use the arrow keys or the joystick to move the cursor to the line containing the name.**
- **Press the GO key or the firing button.** You will see a message to PLEASE WAIT, hear a rising sound, and then the game or program that you have chosen will appear on your screen.

Select an item by the SHORTCUT feature using the same method described for stages one:

- **Move the cursor over SHORTCUT.**
- **Press the GO key or firing button.**
- **Type the exact name of the item (do not use the number).**
- **Press the GO key or firing button.**

Simple, isn't it! Why not run through an example to make sure. Go back to the first stage, select a category, find an item that looks interesting, and transfer it from Cable to your computer. One practice run and you won't have to look at this part of this book again!

The Item You Choose

Your Adaptor knows what you are authorized to use from Cable. If you try to select a category to which you have not subscribed, you will get the message:

SORRY . NOT IN YOUR PACKAGE .

This same message can also appear up to five minutes after a power failure and re-entry of your channel code, even if you have selected correctly.

Your cable company has several different packages or categories that it offers its subscribers. For example, it may offer one games package with so many specific games for one price, and another games package of so many more games for a different price. That's why you may find that there are some games you cannot take from the Cable, even though you have subscribed to a Games Package. (Some cable companies may refer to their packages as "tiers".)

There is a starter package that every subscriber who has paid for a subscription to THE NABU NETWORK always gets. This may contain sample items from each of the other categories.

STEP 2: Interacting With the Program

Once you have loaded a program from Cable, you will use it according to instructions provided separately from this book. To make it easier for you to use the programs, each of the items in a package is made up in accordance with standards set by NABU. No matter which ready-made program you select, each will start with similar advice. This will include:

- How to ask for help for this particular program.
- How to restart this particular program.
- How to exit or leave this particular program.

So the introductory advice might tell you:

READY TO GO? PRESS GO

or

NEED HELP? PRESS HELP

or

NEW CHOICE? PRESS EXIT

or

START AGAIN? PRESS RESTART

This type of advice is necessary because you won't see those handy reminders for HELP and EXIT that you saw in the selection displays. Each program needs that particular area of your screen for other things that have

to do with the game or whatever else the program that you selected is supposed to do.

Time-Out Feature

Another standard that affects all applications is the automatic time-out feature. This feature protects your TV from something called "burn-in". Burn-in occurs when characters or other marks are permanently burned into the screen. It may occur if a display is left on for long periods without being used or changed.

If you have not used the keyboard or games controller with your current program for at least 30 minutes, the computer will automatically blank the computer display on the screen. It will do this even while you are watching TV if you left your PC with a program in it. (It won't blank your TV display, so you won't be aware of it happening to the computer!)

To restore the computer display, press and release any key except CTRL, CAPS or SHIFT.

If you were watching TV when the time-out feature was activated, press the TV<-->NABU key to cancel the time-out and to return the screen to the computer display.

STEP 3: The Farewell Scene

There's more than one way to make an exit from your NABU operation!

If you just wish to leave a program and go back to the second stage of selection, use **EXIT** on your keyboard. **Hold the SYM key down and hit PAUSE.** You will get a display of the page that contains the name of the item you just left.

If you wish to leave the second stage of selection and go back to the first stage:

- **Move the cursor to EXIT, and press the firing button or the GO key.**

or

- **Press the EXIT key.**

or

- **Press the RESTART key.**

or

- **Press the RESET switch.**

If you are in the first selection stage and select **EXIT** again, you will hear a beep sound and get some messages to turn off your equipment or to take some other action.

Assuming you are finished using the computer:

Turn off the computer by hitting the POWER push button.

The lights on the computer will go out, and your TV screen will automatically revert to normal TV. (You may have to change the channel setting on the TV to get your TV program.) When you turn your computer on again, you will automatically be switched to the computer display. (Don't forget that you will have to switch the TV back to channel 3 or 4 if you had switched it to some other channel to watch TV.)

Oops! You Forgot Something!

If you decide not to turn the computer off but just walk away and leave the farewell messages on the screen, the computer will be patient for the next five minutes. Then it will start a rude buzzing. After another minute, it will erase the "turn-off" messages to protect your screen from "burn-in". When you finally give up and return, you will see a message swimming around on your screen that says:

HIT ANY KEY TO RETURN

If you hit a key, you will again see the turn-off messages.

NOTE

Text left undisturbed on a screen for very long periods may cause letters to be permanently burned into the screen. If the computer is to be left unused for a long time, it should be turned off.

IF SOMETHING GOES WRONG

You will find that your NABU PC is a very reliable system, but occasionally something can go wrong. The problem might be as basic as no electrical power or as complex as a refusal to load a program. The cause, though, may be the same - a poor connection!

The poor connection is the most common cause of problems. It is so easy to forget to plug a cord in once you have disconnected it. It is just as easy to trip over one, or pull on it and loosen a connection. The good thing about this is that a poor connection is something you can find and correct.

If you locate and correct a problem that involves only checking lights and connections and perhaps a keyboard operation, you will be back in operation much faster. (It could also be less embarrassing than having a service person find that you had accidentally pulled out a plug!)

In general, here are some things you can do if you run into a problem:

1. **If there is no computer display or the display appears distorted, press a key to check whether the time-out feature has been activated. Then check the TV channels to see whether they are displaying normally. If they are not, the problem could be with the Cable system.**
2. **Check all lights on the computer and the Adaptor.**

On the NABU PC:

POWER light should be **ON**. If it is off, make sure the power cord is connected. If that is okay, check for a wall switch off or a blown fuse on your home fuse panel.

NOTE

There is an internal fuse in the computer which requires removal of the power supply cover to access it. **DO NOT REMOVE THIS COVER.** If you suspect this fuse has failed, call your **HOTLINE**.

PAUSE light should be off. If it is on, the computer will not react to what you do with the games controllers or with most keys on the keyboard. Press **PAUSE** or **GO**.

ALERT light should be off after the computer is turned on. If the red light comes on and stays on, there may be an internal failure or the cables to the keyboard and Adaptor may be loose.

CHECK light should come on each time a key is pressed. If not, check the connections between the computer and the keyboard.

On the Adaptor:

POWER light should be on. If it is off, check whether the power cord is connected and plugged in. If that is okay, check the wall switch (if one controls the power outlets) or the fuses on your home fuse panel.

CABLE light should be on. If it is off, check the connections on the cord that leads to the cable TV outlet on the wall. You may also try inserting the channel code again: pull the power plug on the Adaptor and plug it in again; then turn off your computer and start it up again.

LINK light should be on. If it is off, check the connections on the cable that links the Adaptor to the socket on the computer labelled **ADAPTOR**.

MESSAGE light is reserved for future use and should be off.

3. **Check all connections to make sure they are secure.**
4. **Check CHANNEL 3-4 switch is set to the correct channel.**
5. **If your TV set has fine tuning, try adjusting the fine-tuning control to improve reception. Do not adjust the fine tuning if you have a Pay-TV unit.**
6. **If a program appears to be out of control or the computer refuses to load a program, press the RESET switch on the computer and try again.**
7. **If all of the above fail to get your system working, call the HOTLINE number on the sticker.** The person who answers will probably ask you for information about the lights and suggest other things you might try.

HOW DOES THIS CABLE WORK, ANYWAY?

With the press of a firing button on a games controller or of the **GO** key on your keyboard, you are off and running with the game of your choice, or making notes from the information you selected for display, or writing the next chapter of a book. Well, almost!

Sometimes the system won't give you a particular item you ask for because that item is not in the package you paid for. Sometimes you have a slight wait even when you have made a legitimate request. Sometimes you will get a message you hadn't asked for. How does all this happen and why?

Part of the answer lies in how the information you ask for gets to you via Cable.

THE NABU NETWORK puts together all the games, programs and assorted information services that the cable company offers to its subscribers. These are placed in a particular order in its own large computer, usually located in the cable company's headquarters. The computer starts this parade of offerings down the cable system. It can take up to twenty seconds before the last item in this long list gets on the Cable. Then the computer repeats the whole process.

You could think of the Cable as a turning wheel, with each program, game, etc., in a specific place on the rim. You are standing next to the wheel. As it turns, each of the items comes into your line of vision and, if you have asked for it, it can be loaded from the Cable into your computer's memory (provided it is in the package you paid for!). Your cable company will be pleased to show you how to get any items that are not in the package or tier you have presently subscribed to.

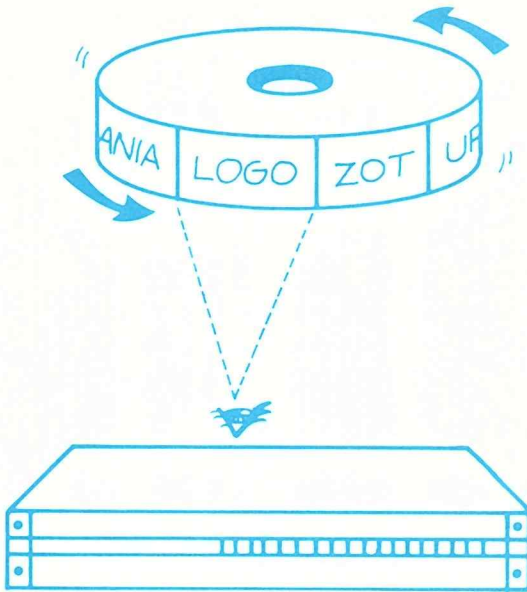

The Cable Wheel

So now you can see why the time required to transfer a selected program to your computer can vary noticeably. If a game you want has just gone by, the computer may have to wait up to 20 seconds before that game shows up again. Luckily, statistics are on your side and the average waiting period is less than 13 seconds!

The part of your system that actually watches the information going by on the Cable is the NABU Adaptor. This clever device:

- remembers what program you have asked for;
- recognizes it when it shows up on the cable;
- decides whether you are entitled to use it; and
- if you are entitled, loads it into your computer.

Whether you are entitled to use a program, of course, depends on which package you have subscribed to. The cable company sends this authorized subscription information (via Cable, naturally!) to your particular Adaptor. It repeats this vital information every five minutes or so just in case something causes the Adaptor to forget. (Think of the channel code as the key that

unlocks the door between the Cable and Adaptor, and the authorization from the cable company as the person who checks that you have the correct ticket before letting a program through for your use.)

One thing that can cause the Adaptor to forget what package the subscriber bought (and the channel code, too) is a power failure. Once the power comes back on, you must re-enter the channel code as described in **STARTING UP YOUR NABU PC**. After doing so, it could be up to five minutes before the Adaptor learns what package you can have.

(If you have Pay-TV, you may have to wait longer than the maximum of five minutes before a TV signal becomes available for viewing. The extra time required is dependent on whatever Pay-TV system your cable company is using.)

A COMPUTER THAT GROWS WITH YOU

The easiest way to introduce the whole family to the computer age is to play the games. In fact, you can have so much fun just challenging yourself with the latest games on Cable that you may forget for a while your computer has other uses.

In time, though, you are going to want to expand your use of the computer, to make it do all those other terrific things you hear that other computers do. When that happens, you will find your NABU Personal Computer is ready to expand with you.

The Practical Programs

Your cable company will have a great variety of programs covering the general areas of education, business, information services, and games.

You may decide, for example, that you want to capitalize on the kids' enjoyment of the NABU PC, by using it as an educational tool. Learning to program a computer in LOGO, a language specifically designed for children by the Massachusetts Institute of Technology, is among the educational programs available on Cable.

Another popular program is word processing, which has both home correspondence and business applications. Or you may want a package that helps you solve such problems as loan and mortgage calculations or what to consider when buying a car or a home.

The Peripherals

You can further increase the practicality of your NABU PC by adding some of the devices that it is designed to use. Called "peripherals", these devices include a printer, an autodialer, and data storage units.

You may acquire a printer, for example, to print out the results of an accounting or word processing program that you are using.

You might want a dial-up device that lets your computer use the telephone lines to send electronic mail or to talk to another computer.

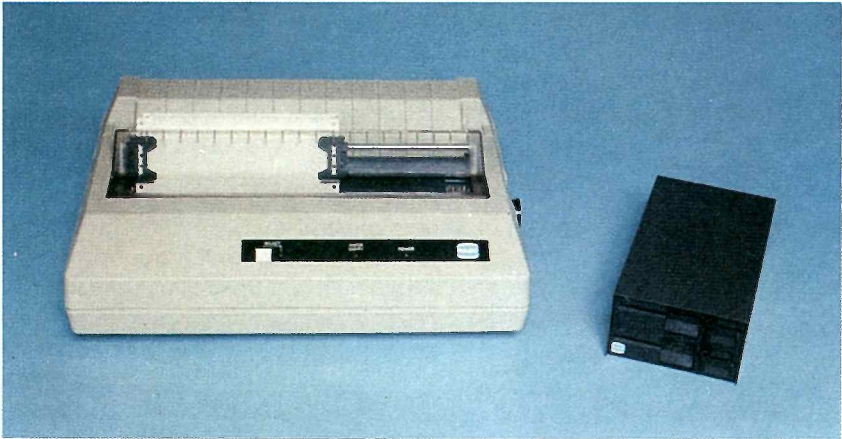

Peripherals - A Printer and a Disk Drive

As you expand to using word processing, or accounting or an electronic filing system, you will need to store your information so that you can readily work on it again. You can add disk drive units or other semi-permanent storage devices for this purpose.

When you are ready for greater things, talk to your cable company and your dealer. They will show you that your NABU Personal Computer and THE NABU NETWORK are ready to grow with you.

QUALITY FEATURES IN YOUR NABU PC

Because of its unique design and integration with cable TV, your NABU PC offers more capability than many computers far above its price range. For example:

- Large Main Memory.

Sixty-four kilobytes available for text and programs (refer to the glossary for a definition of "kilobyte" and other technical terms).

- Separate Graphics Display Memory.

Sixteen kilobytes capable of generating graphic displays in 16 colors (the pictures, playing areas, moving characters, large text and the graphs).

- Versatile Games Controllers.

Games controllers used for games and other applications have at least one firing button and fully controllable movement. One or two are connected through the keyboard.

- Pause Capability.

Puts the computer on hold while you go do something else. When you are ready to continue, it will start from where it left off.

- Computation While You Watch TV.

While the computer is busy doing long tasks you have given it, you can switch over to a regular TV channel without interfering with the computer operation.

- Dynamic, Current and Expandable Selection of Programs and Data.

Selects programs and data from a constantly updated and expanding library available on the Cable.

- Compatible With Component-Type TV.

Has separate audio and video outputs that can be fed to your stereo and separate video monitor.

- Built-in Diagnostics Capability.

Uses messages and lights to check out the system and to alert you to simple problems such as a cable needing to be connected.

- Grows With the Family - Expandable.

Add a printer, a disk drive or telephone communicator to it when you are ready to expand.

- Versatile Keyboard With Key Pad.

Full range of function keys, cursor control, legend for special key functions, autorepeat.

- Convenient, Sleek, Uncluttered Design.

A single, long cable connects the keyboard to the computer. Sit almost anywhere! Games controllers are connected through the keyboard - no tangled wires.

NABU PC TECHNICAL SPECIFICATIONS

Item	Description
PROCESSOR:	Zilog Z80A 8-bit microprocessor.
CLOCK SPEED:	3.58 MHz.
MAIN MEMORY:	64 Kilobytes (65,536 bytes) of dynamic RAM for program and data storage.
ROM MEMORY:	4 Kilobytes (4,096 bytes) used for self-test diagnostics and initial loading of the operating system software.
VIDEO MEMORY:	16 Kilobytes (16,384 bytes) of dynamic RAM for exclusive use by video processor.
DISPLAY PROCESSOR:	Text Mode - Provides twenty-four 40-character rows in two colors (foreground and background). Graphics Mode - Provides 32 x 24 definable pattern positions, each composed of an 8 x 8 pixel group, for total screen resolution of 256 x 192 pixels; 15 colors plus transparent capability; sprite-oriented, hardware-supported animation.
SOUND GENERATOR:	Programmable sound generator featuring three independently controllable channels, tone and noise generation, amplitude and envelope control for complex sound generation.
KEYBOARD:	Detachable, microprocessor-controlled, full-stroke keyboard with 2-key rollover and autorepeat; 66 keys (58 on main

Item	Description
KEYBOARD: (cont.)	keyboard plus 8-key group for cursor control, paging and YES/NO response); Control Keys - SHIFT , CAPS , and CTRL ; additional special function keys - TV/NABU , PAUSE and SYM ; two DB-9 connectors capable of supporting games controllers featuring 8-position joystick and fire button control in a single unit; 6-pin DIN receptacle for connection to NABU Personal Computer.
PRINTER PORT:	DB-15 connector; 8-bit parallel printer port (with handshaking).
ADAPTOR INTERFACE:	5-pin DIN receptacle; EIA RS-422 compatible serial port for connection to the NABU Adaptor.
VIDEO OUTPUT:	RCA phono jack; 75 Ohm, 1V p-p + -6dB negative sync, composite video output will drive standard NTSC monochromatic or color monitor. Maximum DC offset + 1.0V.
AUDIO OUTPUT:	RCA phono jack; 10 kilohm output impedance, 1.5V p-p signal for driving separate audio amplifier or input (if so provided) on monitor.
CABLE INPUT:	Type-F connector; 75 Ohm CATV CABLE input to provide signal for normal TV viewing.
TV (RF) OUTPUT:	Type-F connector; keyboard selectable output of internal RF modulator or the regular CABLE Input signal, allowing the user to switch between a computer-

Item	Description
TV (RF) OUTPUT: (cont.)	generated display or normal TV viewing; RF modulator output on channel 3 or 4 is selected by rear panel switch.
EXPANSION:	Four 30-pin expansion ports for NABU option cards. Access slots at rear of enclosure.
POWER REQUIREMENTS:	105-125 Vac, 57-63 Hz, 60 VA maximum. Maximum power dropout 1/2 cycle.
ENVIRONMENT:	Ambient Operating Temperature: + 10 C to + 35 C. Storage Temperature: -20 C to + 70 C. Humidity: 10% to 90%, non-condensing.

Specifications subject to change without notice.

Z80A[®] is a registered trademark of Zilog, Inc.

NABU ADAPTOR TECHNICAL SPECIFICATIONS

Item	Description
DATA RATE:	6.312 Mbits
NOMINAL INPUT SIGNAL REQUIRED:	-9 dBmV or greater
MODULATION METHOD:	O-QPSK
AVAILABLE CHANNEL:	Assigned by NABU
CATV FREQUENCY RANGE:	54-450 MHz
INPUT IMPEDANCE:	75 ohms
RETURN LOSS:	> 4dB (54-270 MHz)
NOISE FIGURE: (with channel bandpass filter)	18 dB
INSERTION LOSS:	> 4dB (54-270 MHz)
OPERATING TEMPERATURE:	+ 10 C to + 35 C
STORAGE TEMPERATURE:	-20 C to + 70 C
HUMIDITY:	10% to 90% (non-condensing)
POWER REQUIREMENTS:	105 to 125 Vac. 57 to 63Hz. 30 VA maximum

GLOSSARY

Term	Definition
Application	See Program.
Authorization	A message transmitted by the cable company to each specific NABU Adaptor to tell it what programs the user is allowed to copy from Cable.
Banner line	A line on a display normally reserved to display messages to the user.
Byte	A byte is a measure of storage capacity. One byte can store one character (e.g. the word HELLO would require five bytes). See also Memory.
Cable	As used in this book, Cable, with a capital C, refers to cable television. Otherwise, it is a communication link between the various devices that make up the NABU Personal Computer.
Channel	A path along which electronic information travels. There may be several separate channels in use on Cable at the same time.
Category	A major division or class of programs offered on THE NABU NETWORK. Typical category names are Games and Education.
Character	A single letter, number, space or special symbol entered from the keyboard.
Configuration	The selection and interconnection of the individual parts of the NABU PC to make up the complete system. The required configuration is dependent on the type of TV set used.

Term	Definition
Connector	The plug at the end of a cable or the receptacle on a device into which the plug fits.
Controller	A device used to make a program selection or to control the action of a game. Usually called a games controller.
Converter	A device used to change the frequency of cable channels so that more channels can be received on a standard TV set.
Cursor	A symbol on the screen which indicates where on the screen the next action will occur.
Data	Information stored and used by the computer.
Diagnostics	Procedures used to locate and identify a fault.
Disk drive	A device which reads and writes information on magnetic disks.
Diskette	An oxide-coated, flexible plastic magnetic disk used to store information. Sometimes called a "floppy" or "mini-floppy". It is sealed in a protective envelope.
Enter	To type information onto the screen, and cause the computer to accept it by pressing the GO key.
Graphics	A design or pictorial presentation produced by the computer.
Help	A set of instructions that appear on the screen, when requested. They are intended to assist the user in interacting with the computer. May be invoked by the HELP key or by selecting the HELP feature on the selection display.

Term	Definition
Interface	The matching of one part of a system to another part of a system so that one can understand or communicate with the other. For example, the keyboard is the interface that translates the user's actions into a form that the computer understands.
Keypad	The small group of keys located to the right of the main keyboard.
Kilobyte	A measure of memory or storage capacity. One kilobyte = 1024 bytes.
Load	To transfer information into the computer's memory from Cable (e.g. load a game program).
Language	A code that the computer understands.
Memory	An area in the computer where information and instructions are stored until the computer needs them to perform calculations, produce text or graphics and do other jobs. See also ROM and RAM.
Menu	A list of options from which the user makes a selection (e.g. Games, Education and Family are typical names of the options in the main menu).
Package	A group of programs to which a NABU PC user has subscribed and which the Adaptor recognizes the user is entitled to.
Program	A sequence of instructions that tells the computer step-by-step how to carry out a task. An application is the general name given to a type of program that does a special job or has a special use (e.g. word processing, accounting, or game).
RAM	Random Access Memory. A section of the computer's memory intended to store information

Term	Definition
RAM (cont.)	and instructions of a temporary nature. This information disappears when the power is turned off.
Reset	An action caused by pushing the RESET switch that takes the computer back to one of two basic starting points, no matter where it is in any program. The starting points are the beginning of the diagnostics or the first stage of selection.
ROM	Read Only Memory. A section of the computer memory in which information is permanently stored. It is not destroyed when the power is turned off.
Screen	The display surface of the TV set or video monitor.
Selection	The process of choosing a program to be loaded from Cable. Selection is made in stages: category selection, followed by program or item selection. It may also be made directly by typing the name of the desired program.

INDEX

- A -

A Computer That Grows With You			49
A Quick Tour of Your NABU Personal Computer			7
About This Guide			2
Adaptor	5,	9,	10,
Adaptor Power			47
Alert			31
Alert Light		44,	45
Applications			30
Arrangement			24
Arranging Your System			10
Arrow Keys			10
Audio			35
Authorized			21
Autodialer		40,	47
Autorepeat			49
		24,	25

- B -

Banner Line			37,	39
BREAK				28
Burn-in			42,	43

- C -

Cable		4,	5,	45
Cable-ready				17
CAPS			26,	42
Category			34,	37
Category Menu				36
Channel				21
Channel Code		3,	31,	41
Channel Setting				43
Channel Switch Setting				3
Channel 3-4				7
Channel 3-4 Switch				22
CHECK			30,	45
Color				30

INDEX

Component		12,	21
Component TV			27
Computer			7
Connection		19,	21,
Connections			44
Connectors			17
Converter	10,	12,	22,
CTRL			30
Cursor		29,	35,
			40

- D -

Data Storage Units			49
DELETE		27,	36
Direct Selection			33
Disk Drive Units			50
Display		32,	44
Down Arrow			28

- E -

ESC			28
EXIT		27,	39,
Exiting			42
			37

- F -

Fine-tuning			45
Fire			8
Firing Button			35

- G -

Games Controller	8,	17,	19,
Games Controllers			21
Getting Started			51
Getting to Know Your Keyboard			30
Glossary			23
			57

INDEX

GO		26
- H -		
HELP	23, 27,	36
Hotline	2,	45
How Does This Cable Work, Anyway?		46
- I -		
If Something Goes Wrong		44
Instant Help Sticker		2
Interconnecting Cables		11
Internal Fuse		44
Introduction		1
Item		32
Items		37
- J -		
Joystick	8,	35
- K -		
Keyboard	23,	32
Keypad		8
- L -		
Left Arrow		28
Legend		26
Lights	30,	44
LINK		45
Load		45
LOGO		49

INDEX

- M -

Main Memory				53
Main Menu				34
Making the Right Connections				10
Memory	30,	31,		51
Menus				32
Message				45
Messages				30
Modular				12
Modular TV				21

- N -

NABU Adaptor Technical Specifications				56
NABU PC				2
NABU PC Technical Specifications				53
NABU Personal Computer				7
NO				28
Number One				17
Number Three				21
Number Two				19

- O -

Oops! You Forgot Something!				43
-----------------------------	--	--	--	----

- P -

Package				46
Packages				41
Page				38
Page Backward				39
Page Forward				39
Page Key				29
Paging Arrows				38
PAUSE		27,	30,	44
PAY-TV	12,	19,	45,	48
Peripherals				49
Phono Jack				21

INDEX

Phono Jacks			17,	19
Plugs				12
Power	30,	43,	44,	45
Power Failure			41,	48
Power Requirements			55,	56
Printer				49
Problem				44
Program		23,	24,	41
Programs				49

- Q -

Quality Features in Your NABU PC				51
----------------------------------	--	--	--	----

- R -

RESET		31,	43,	45
RESTART			28,	42
Right Arrow				28
ROM Memory				53

- S -

Selection	32,	34,		37
Self-test				30
Separate Converter				19
Setting the Channel 3-4 Switch				22
SHIFT			26,	42
SHORTCUT			36,	40
Sockets				12
Sound				30
Sounds				30
Special Features			35,	39
Special Function Keys				24
Stage One			33,	34
Stage Two			33,	37
Standards				41
Start Up				30
Step 1: Selecting an Item				32
Step 2: Interacting With the Program				41

INDEX

Step 3: The Farewell Scene		42
Subscribers	41,	46
SYM	23,	26

- T -

Table		25
The Adaptor		9
The Adaptor Box Contents		5
The Banner Line		37
The EXIT Feature		37
The Games Controllers		8
The HELP Feature		36
The Item You Choose		40
The Keyboard		8
THE NABU NETWORK	41,	46
THE NABU NETWORK Guide		34
The NABU PC Box Contents		4
The NABU Personal Computer		7
The Peripherals		49
The Power Cords		22
The Practical Programs		49
The SHORTCUT Feature		36
The Special Function Keys		24
Tier		46
Tiers		41
Time-out Feature		42
Transfer		31
Transformer	17,	19
TV Set		10
TV Tuner		21
TV<-->NABU	21, 23,	27, 42

- U -

Unpacking Your NABU Personal Computer		4
Up Arrow		28

INDEX

Using Your NABU Personal Computer 32

- V -

Video 21
Video Memory 53
Video Monitor 10, 13, 17, 19

- W -

Which Connections to Use 12
Word Processing 49
Wrap Around 35

- Y -

YES 28

NOTES

NOTES

NOTES





NABU
Manufacturing
Corporation